

REV NO.	DATE	REVISION	DR	CH	APP
△					

# SPECIFICATION

- Rating : 150mA, DC 42V (Switching)  
200mA, DC 42V (None-Switching)
- Contact Resistance : 80mΩ Max
- Insulation Resistance : 100MΩ Min at DC 250V
- Operating Force : 700gf Max
- Life cycle : 10,000 steps
- Sealing : IP67 (Dust & Water proof)
- Packing : 50pcs Tube

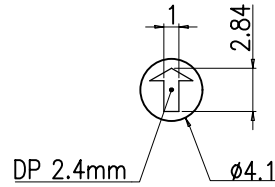

ACTUATOR

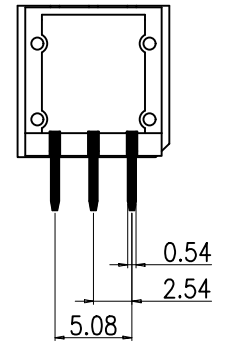
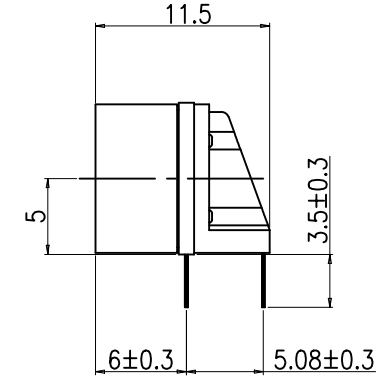
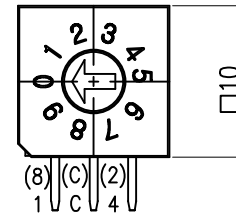

10 P o s i t i o n	Real Coded					0
	C	1	2	4	8	
0	●					0
1	●	●				1
2	●		●			2
3	●	●	●			3
4	●			●		4
5	●	●		●		5
6	●		●	●		6
7	●	●	●	●		7
8	●				●	8
9	●	●			●	9

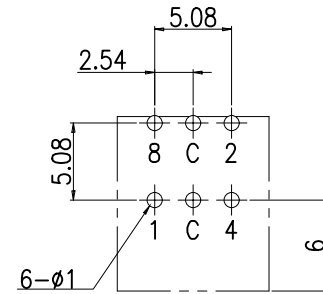

P.C.B DIMENSION (Top View)

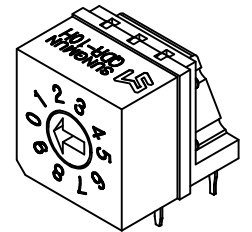
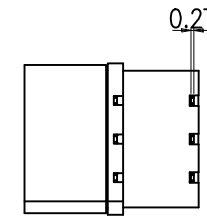

Din ISO-2768-1m					
Ranges	0.5~3	3~6	6~30	30~120	120~400
Tolerance	±0.1	±0.1	±0.2	±0.3	±0.5

DRAW/DESIGNED	CHECKED	APPROVED	G.T.C.	ROTARY DIP SWITCH	
H.S LEE	K.N KIM	W.J LEE	UNSCALE	QDR-10H	REV.
2023-09-05	2023-09-05	2023-09-05	MODE NO	QDR-10H(LG)-01	01
邦斯达 BONSDA Electronics 深圳市子庚科技有限公司			SIZE A4		

